

ジョーを開いた図

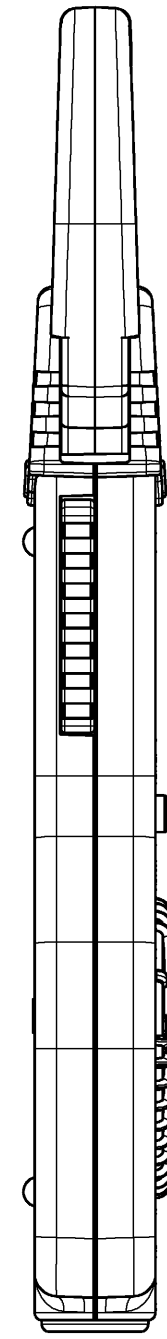

Mesurable cable diameter
測定可能最大導体径
φ33

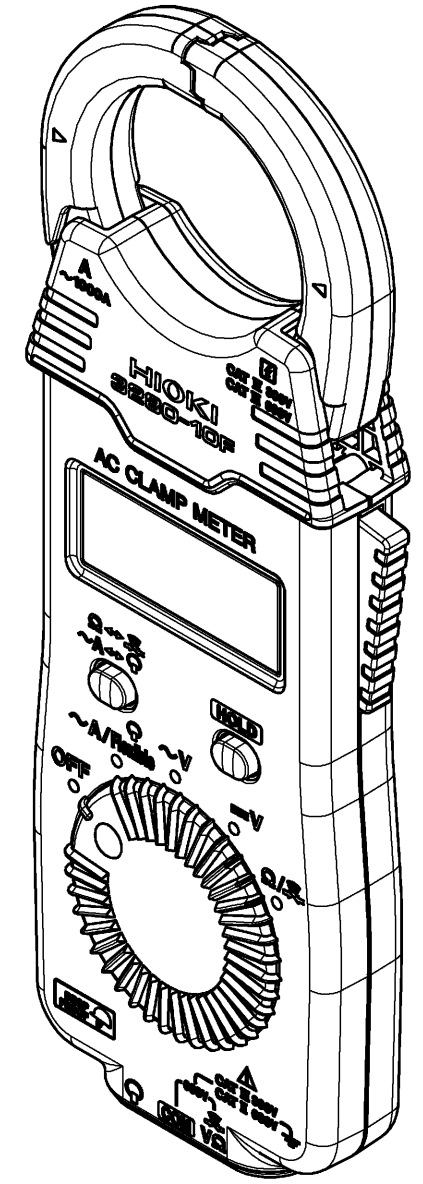
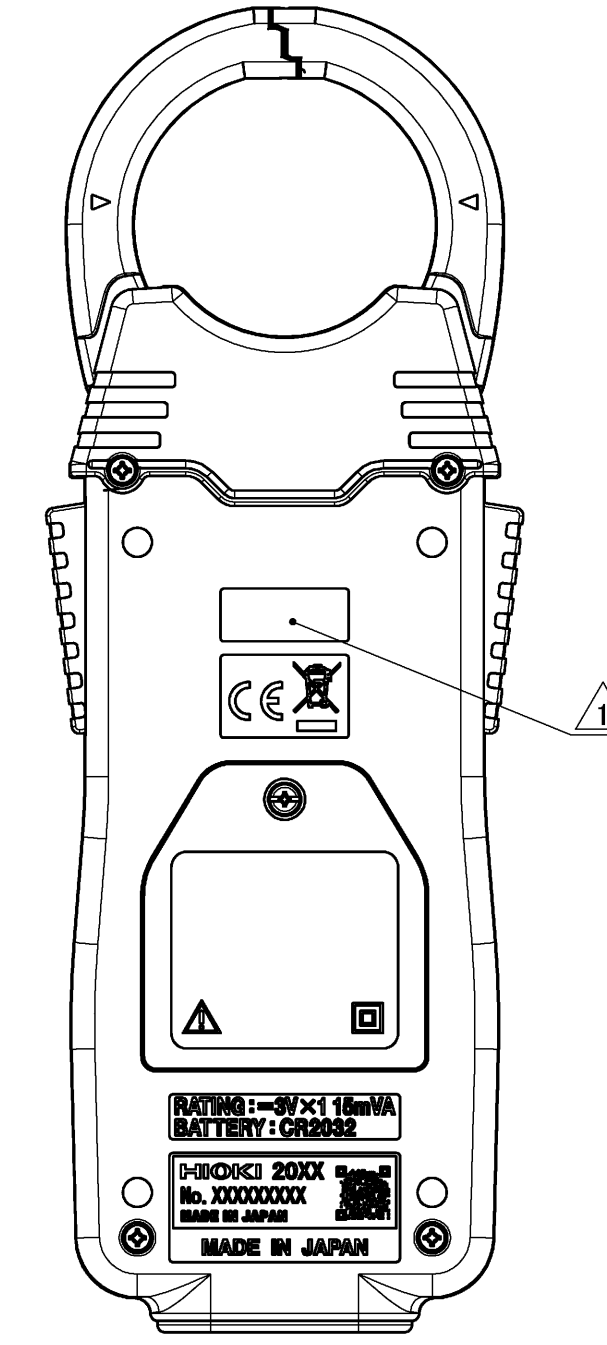
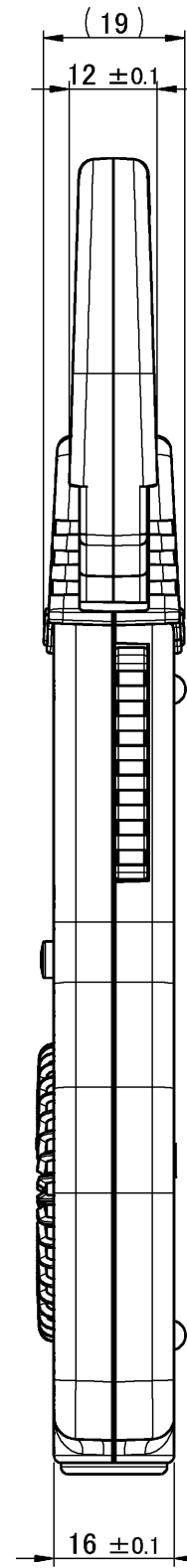
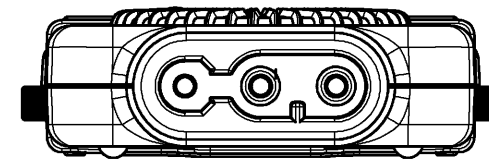
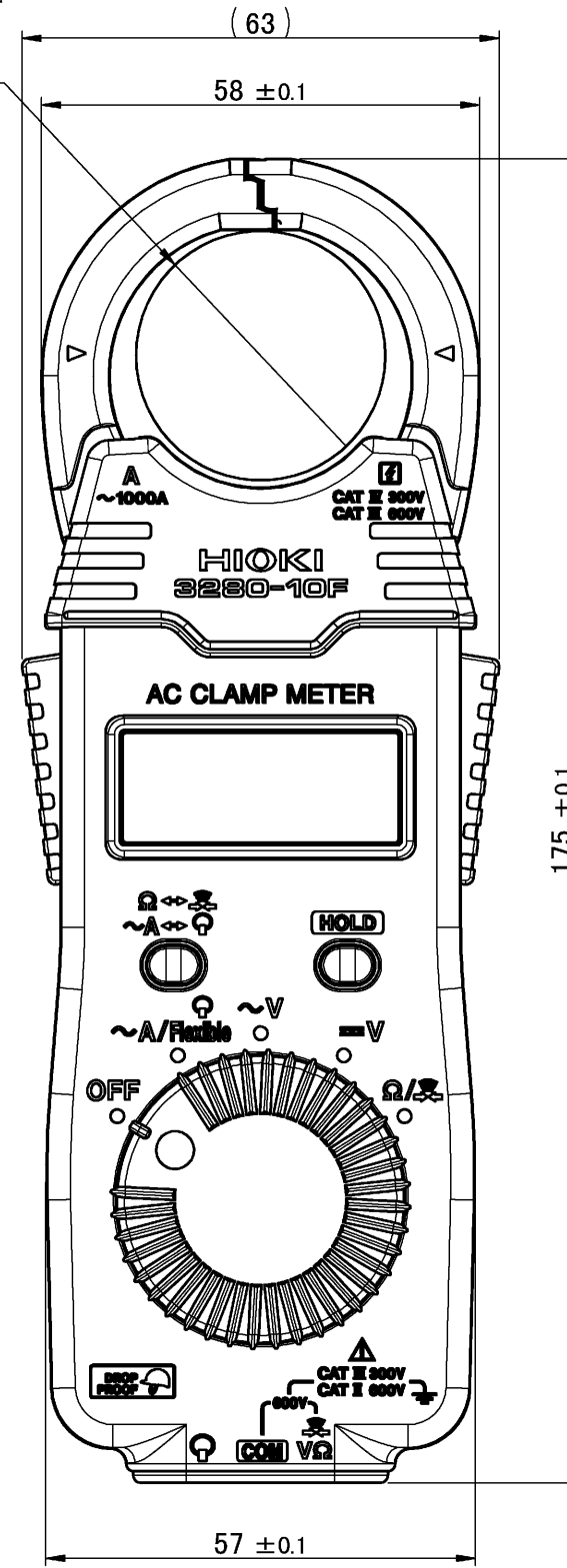
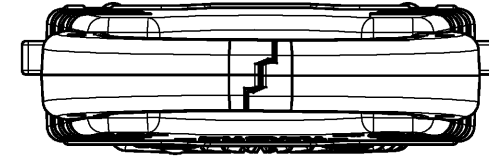

CAD data: 3280H040_01_Outline_Drawing						
材質 Material	—		承認 Approved by 戸井 順	投影法 Projection Method	第一角法	形名 Model 3280-10F
処理 Finish	—		検査 Checked by 戸井 順	尺度 Scale	1:1	単位 Unit mm
初版 Orig.	2019/08/20	永井明博	KCマーク削除	設計 Designed by フルネーム	永井明博	図番 Draw No. 3280H040
初版 Orig.	2015/09/09	池田大輔	新規作成	シート Sheet	1 / 1	シートサイズ Sheet Size A2
履歴 Sym.	YYYY/MM/DD 日付 Date	設計 Designed by	注記 Description	版 Rev.		01